

Solar Charge Controller

Adjustable, for hybrid and telecommunication systems



Tarom 4545 (12 V/24 V accumulator)

Tarom 4545-48 (12 V/24 V/48 V accumulator)

Installation and operating instructions

Table of contents

1	General safety instructions	5
2	Identification	6
3	Scope of delivery	7
4	Proper usage.....	8
5	Markings	9
5.1	Symbols for warnings and notices.....	9
5.2	Keywords.....	9
6	Quick guide	10
7	Overview of the controller	11
8	Menu structure.....	12
9	Installation.....	13
9.1	Safety instructions.....	14
9.2	Connections and operating buttons	16
9.2.1	StecaLink slave connection	16
9.2.2	StecaLink master connection	19
9.2.3	Slot for microSD card (④ in Fig. 1)	20
9.2.4	Relay outputs AUX 1, AUX 2 (⑨, ⑩ in Fig. 1).....	20
9.2.5	Temperature sensor connection TEMP (⑧ in Fig. 1).....	21
9.2.6	Open UART interface, 3.3 V (⑦ in Fig. 1).....	21
9.2.7	Function ground (③ in Fig. 1)	22
9.2.8	Operating buttons	23
9.3	Removing/installing the cover.....	23
9.3.1	Removing the cover	23
9.3.2	Installing the cover	24
9.4	Installing the device.....	24
9.5	Establishing the electrical connections	25
9.5.1	Preparing the cables	26
9.5.2	Connecting the battery.....	26
9.5.3	Connecting the solar module.....	27
9.5.4	Connecting loads.....	28
9.5.5	Connecting optional components.....	29

10	Performing initial commissioning	31
11	Dismounting the controller	34
12	System functions	35
	12.1 Protection functions	35
	12.1.1 Controller overload	35
	12.1.2 Overheating of the controller	35
	12.1.3 Deep discharging of the battery	35
	12.2 Control mode	36
	12.3 Battery charging functions	37
	12.3.1 Float charging	37
	12.3.2 Boost charging	37
	12.3.3 Equalise charging	38
	12.4 Data logger	38
13	Display (layout, function, operation)	39
	13.1 Overview (menu structure)	39
	13.2 Status display	39
	13.3 Display of special states	41
	13.4 General operation	42
	13.5 Advanced operation	42
14	Control functions	44
	14.1 Overview	44
	14.2 Operation	45
	14.3 Functionality	47
	14.3.1 Deep discharge protection	48
	14.3.2 Morning light function	48
	14.3.3 Evening light function	49
	14.3.4 Night light function	49
	14.3.5 Excess energy control	50
	14.3.6 Generator manager	50
	14.3.7 Alarm	51
	14.3.8 Timer 1 ... 4	51

14.3.9	StecaLink bus.....	52
14.3.9.1	StecaLink slave address setting	52
14.3.9.2	StecaLink master setting	53
14.3.9.3	Changing the slave settings	54
14.3.10	SD card.....	56
15	Troubleshooting.....	58
15.1	Event messages	58
15.2	Errors without event messages.....	64
15.3	Self test	65
16	Maintenance.....	66
16.1	Controller	66
16.1.1	Removing dust.....	66
16.1.2	Removing heavy soiling	66
16.1.3	Checking the charging functionality	67
16.1.4	System	67
17	Disposal.....	68
18	Technical data.....	69
18.1	Controller	69
18.2	Connection cables	71
18.3	Protocol of the open UART interface	72
18.3.1	Settings	72
18.3.2	UART Data	73
18.4	Recording data on an SD card	75
18.4.1	Master data file	76
18.4.2	TIMECHG data file.....	77
18.4.3	PA HS400 data file.....	78
19	Guarantee conditions	79
19.1	Exclusion of liability.....	79
20	Contact.....	80
21	Notes.....	81

1 General safety instructions

- This document is part of the product.
- Only technical professionals may perform the work described in this manual.
- Install and use the device only after reading and understanding this document.
- Always perform the measures described in this document in the sequence specified.
- Keep this document in a safe place for the entire service life of the device. Pass the document on to subsequent owners and operators of the device.
- Incorrect operation can reduce solar system yields or damage system components.
- The device must not be connected to the DC cables if it has a damaged casing.
- If one of the following components is damaged immediately take the device out of operation and disconnect it from the battery and modules
 - Device (not functioning, visible damage, smoke, penetration of liquid etc.),
 - Connected cables,
 - Solar module.

Do not switch the system on again before

- the device has been repaired by a dealer or the manufacturer,
- damaged cables or solar modules have been repaired by a technical specialist.
- Battery acid splashes on skin or clothing should be immediately treated with soap suds and rinsed with plenty of water. Immediately seek medical advice in the case of injuries.
- If battery acid splashes into the eyes, immediately rinse with plenty of water and seek medical advice.
- Never cover the device.
- Do not open the casing: Risk of death. Invalidation of the guarantee.
- Factory labels and markings must never be altered, removed or rendered unreadable.
- Observe the manufacturer's manual when connecting an external device that is not described in this document. Incorrectly connected devices can damage the controller.
- This device is not intended for
 - children,
 - persons with physical, sensory or mental impairment,
 - persons without sufficient experience or knowledge unless they are instructed in the use of the device, and initially supervised, by a person responsible for their safety.

2 Identification

General information

Feature	Description
Type	Tarom 4545, Tarom 4545–48
Issue version of the manual	Z03
Manufacturer's address	See nameplate on the charge controller
Optional accessories	<ul style="list-style-type: none">■ External temperature sensor Steca PA TS-S■ Current sensor PA HS400■ StecaLink termination plug

Display

The controller indicates the version of the manual matching the software under *'Main menu'* ► *'Information'* ► *'System info'*

3 Scope of delivery

- Tarom 4545 or Tarom 4545–48
- Operating instructions







4 Proper usage

The solar charge controller, hereinafter named as the *controller* or *device*, may only be used in stand-alone photovoltaic systems for charging and controlling a lead-acid battery containing liquid or gel electrolyte. The following applies in addition:

- The controller must not be connected to the public power grid.
- Only solar modules may be connected to the solar module connection.
- Depending on the battery used, the connected loads must be suitable for use with one of the following voltages:
 - Tarom 4545: 12 VDC, 24 VDC
 - Tarom 4545–48: 12 VDC, 24 VDC, 48 VDC
- The controller performs the following tasks:
 - Monitoring of the battery charging process
 - Controlling of the charging process, protection of the battery from overcharging
 - Switching loads on and off, protection of the battery from deep discharge

5 Markings

5.1 Symbols for warnings and notices

Symbol	Description	Location
	General danger warning	Manual
	Danger from electricity	Manual
	Read the manual before using the product.	Device
	Danger from hot surfaces	Manual, Device
	General information.	Manual
	The following information describes prerequisites for further operation	Manual

5.2 Keywords

The following symbols are used in conjunction with the symbols from chapter 5.1.

Keyword	Description
Danger	immediate danger of death or serious bodily injury
Warning	possible danger of death or serious bodily injury
Caution	possible danger of light or medium bodily injury
Notice	possible damage to property
Note	note on operation of the device or use of the manual

6 Quick guide



DANGER!

Risk of death by electrocution. Observe the safety instructions in chapter 9.1.

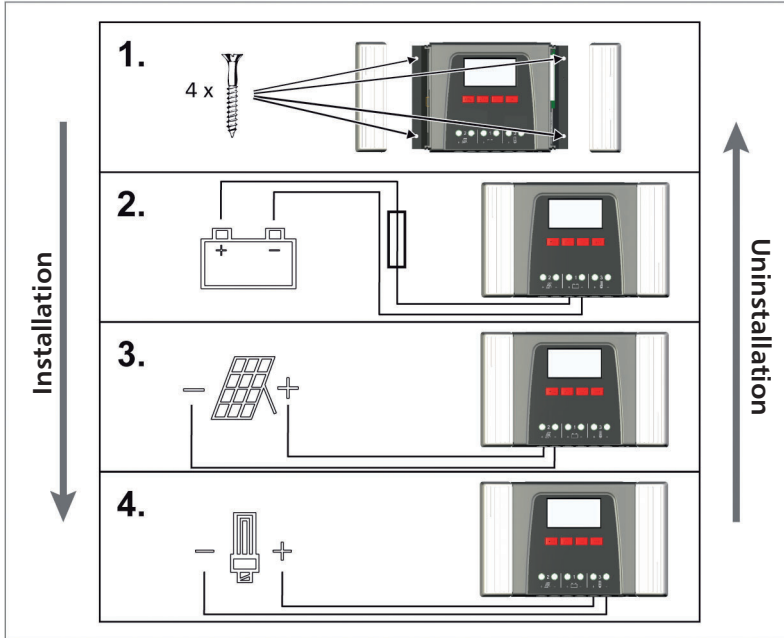

9 Installation

i

The following section describes only the installation of the controller. Observe the respective manufacturer's manual when connecting external components (solar module, battery, load, sensors).

9.1 Safety instructions



DANGER!

Risk of death by electrocution! Observe the following safety instructions when performing the measures described in the installation section.

General information

- Only technical professionals may perform the work described in the 'installation' section.
- Do not open the controller case.
- All covers must be installed during operation.
- **Always** take the following measures before working on the controller:
 1. Switch off all loads.
 2. If present, switch off the DC load circuit breaker (solar module) and secure it against being switched on again or safely cover the solar module (wind).
 3. Switch off the external battery fuse: Remove the fuse insert from the fuse holder (safety fuse) or switch off the DC line circuit breaker and secure it against being switched on again.
 4. Disconnect the battery cable from both battery terminals.

Cable connections

- The module cables carry voltage when the solar module is illuminated.
- Insulate exposed cable ends with insulation tape or wire connector blocks.
- Connect the cables for the battery, solar module and loads to the controller in the described sequence.
- Secure the connected cables with a strain relief clamp, see Quick Guide section 6. Clearance of strain-relief to controller: 200 mm.
- Connect only 1 cable to each connection terminal.
- Cables used: Observe the specifications in the Technical data section.
- Lay the cables so that
 - connections cannot accidentally come loose,
 - persons cannot tread on or trip over these,
 - fire protection devices must not be impaired.
- The entire installation must be designed with Protection Class II if the open-circuit module voltage exceeds 60 V DC at least once anywhere over the entire temperature range.
- Observe all applicable installation regulations and standards, national laws and connection values specified by the regional power supply company.

Fuses and switching devices

Installation of an external battery fuse (line fuse or DC line circuit breaker) is mandatory. Observe the following:

- Mount the external battery fuse directly next to the battery.
- The external battery fuse must conform to the specifications in the technical data section.
- The external battery fuse is not included in the scope of delivery.

**WARNING!**

Danger of acid injuries.

- Do not subject the battery to open flames or sparks.
- Provide adequate ventilation in the installation location of the battery. Inflammable gases can escape from the battery.
- Follow the charging instructions of the battery manufacturer.

**ATTENTION!**

Danger of destroying the device through overloading.

- Conform to the technical specifications, especially the connection values. See the type plate and section 18.
- When selecting the solar module, note that the open-circuit module voltage is higher than the value specified on the type plate at temperatures below 25 °C.
- Connect only 1 controller to each solar module.
- Tighten the connection terminals as shown: Battery, solar module and loads with 2.5 ... 4.5 Nm

9.2 Connections and operating buttons

The following section describes the connections and operating buttons. For information on the display and operation see section 13.

9.2.1 StecaLink slave connection



NOTICE!

- The StecaLink slave connection is an RS-485 communication interface using a proprietary bus protocol.
- The StecaLink slave connection allows connection of superordinate communication levels and control devices. The superordinate communication partner functions as the master and controls the device via the StecaLink slave interface.
- A standard RJ45 network cable (CAT-5 Patch cable, 1:1) is used for connecting StecaLink communication bus members.
- The last unused StecaLink slave connection of a communication chain must be terminated. A termination plug can be acquired separately at your Steca dealer.
- A StecaLink slave device may only be connected to one StecaLink master. Multiple StecaLink slave devices are connected to form a communication chain. Only one StecaLink slave device is connected to the StecaLink master device.
- Up to 5 PA HS 400 current sensor units can be connected via the StecaLink master socket to a Tarom 4545 / Tarom 4545-48.
- The StecaLink slave bus is not galvanically isolated from the power supply unit of the Tarom 4545 / Tarom 4545-48.
- At the device, at the StecaLink master connection, a supply voltage is available for slave devices that do not have an own voltage supply. By connecting a slave to the StecaLink master, the supply voltage is looped through the slave members.
- Each slave must have its own unique address within a range of 1 to 99. No duplicate addresses may be present. Set the address of the slave according to the slave manual.
- The maximum length of the entire bus cabling should not exceed 25 m.
- The Tarom 4545 / Tarom 4545-48:
 - has 2 StecaLink slave bus connections,
 - is a slave for Tarom MPPT 6000-M devices at the StecaLink slave connection,
 - has a StecaLink master connection,
 - is always the master at the StecaLink master connection.

1. ➤ Set a unique slave address at the device with the StecaLink slave connection; see section 14.3.9.1 'StecaLink slave address setting'.
2. ➤ Connect the StecaLink slave connection to the '*StecaLink master*' connection of the superordinate master device.
3. ➤ Use a free '*StecaLink slave*' connection for looping the connection through further slaves.

4. Terminate the free 'StecaLink slave' connection of the last slave member using the termination plug.

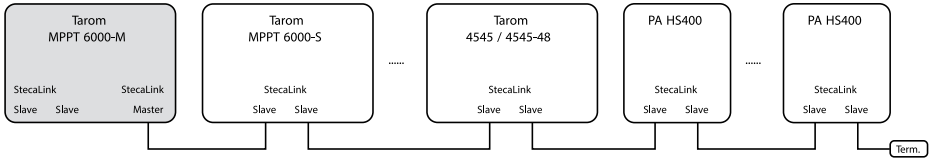

Fig. 2 Bus cabling example using an MPPT 6000-M, MPPT 6000-S, one Tarom 4545/4545-48 and PA HS400 current sensors

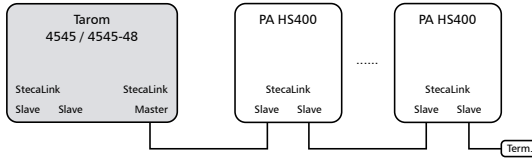

Fig. 3 Bus cabling example using one Tarom 4545/4545-48 and one or more PA HS400 current sensors

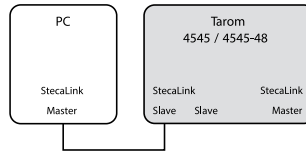

Fig. 4 Example of connecting a PC to the Tarom 4545/4545-48, e.g. for the update function

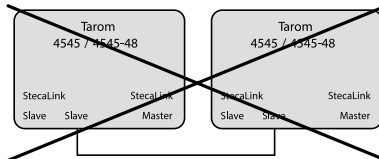

Fig. 5 The connection of Tarom 4545/4545-48 slave connection to other Tarom 4545/4545-48 slave connections, other charge controllers or PA HS400 without master is not permitted

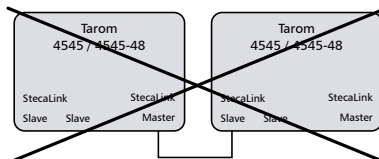
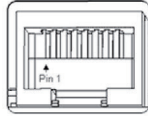

Fig. 6 The connection of Tarom 4545/4545-48 master connection to other Tarom 4545/4545-48 slave connections is not permitted

The bus cable pin assignments are specified in the following table.



Pin	1	2	3	4	5	6	7	8
Signal (master socket)	A	B	-	+ Battery voltage ¹⁾	-	-	GND ²⁾	GND ²⁾
Signal (slave socket)	A	B	-	-	-	-	GND ²⁾	GND ²⁾

¹⁾ The battery voltage is looped through from the master as supply voltage for slaves.

²⁾ GND or rather battery minus

9.2.2 StecaLink master connection



NOTICE!

- The StecaLink master connection is an RS-485 communication interface using a proprietary bus protocol.
- The StecaLink master connection allows the connection of subordinate communication partners.
- The StecaLink slave devices connected to the StecaLink master connection are controlled by the Tarom 4545 / Tarom 4545-48 as communication master.
- E.g. external current sensors PA HS400 can be connected to the StecaLink master connection.
- A standard RJ45 network cable (CAT-5 Patch cable, 1:1) is used for connecting StecaLink communication bus members.
- Termination plugs for the StecaLink communication bus are available as accessories. The communication network connected to the StecaLink master must be terminated at the last free StecaLink slave connection.
- No further StecaLink master may be used in the communication network that is connected to the StecaLink master connection.
- The Tarom 4545 / Tarom 4545-48 can manage a maximum of 5 PA HS400 units.
- Each slave must have its own unique address within a range of 1 to 99. No duplicate addresses may be present. Set the address of the slave according to the slave manual.
- The maximum length of the entire bus cabling should not exceed 25 m.
- The controller:
 - has 1 StecaLink master connection,
 - has 2 StecaLink slave bus connections,
 - is always the master at the StecaLink master connection.



ATTENTION!

Tarom 4545 / Tarom 4545-48 devices can only communicate via the StecaLink bus if they have a serial number from 757324 / 757325 or higher, as well as a APP software version 1.7.0 or higher.

It is never permitted to integrate more than one Tarom 4545 / Tarom 4545-48 in a StecaLink bus because otherwise dangerous compensation currents may occur!

1. ➔ Set a unique slave address on the device with the StecaLink slave connection, see section 14.3.9.1 'StecaLink slave address setting'.
2. ➔ Plug the slave device into the StecaLink master connection. Connect the '*MASTER for StecaLink Bus*' connection to the '*SLAVE IN for StecaLink Bus*' connection.
3. ➔ If further slaves shall be connected, connect them via the slave device, at its free '*SLAVE OUT für StecaLink Bus*' connection.

4. ➤ On the last slave member, terminate the free 'StecaLink Slave' connection with the termination plug.
5. ➤ Register and configure the added StecaLink slave devices on the master device, see section 14.3.9.2 'StecaLink master setting'.

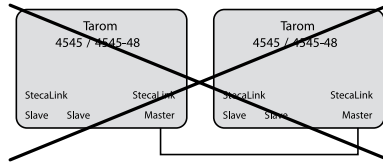

Fig. 7 Master/slave connection of two Tarom 4545/4545-48 via the master connection is not possible

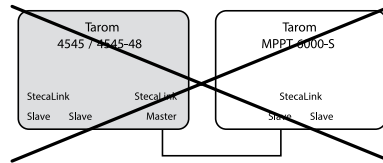

Fig. 8 Tarom 4545/4545-48 / Tarom MPPT 6000-S connection is not possible without Tarom MPPT 6000-M

StecaLink bus cable pin assignment: see page 23.

9.2.3 Slot for microSD card (④ in Fig. 1)

Data can be logged and parameters can be saved on an inserted microSD card (not included in scope of delivery). See 'Commissioning of the microSD card' in section 9.5.5.

9.2.4 Relay outputs AUX 1, AUX 2 (⑨, ⑩ in Fig. 1)

The relay outputs can be used for switching devices or loads (loads via an external power relay).

Devices connected to the relay outputs are controlled via the control functions provided by the controller. Relay output pin assignments:

AUX 1	AUX 2	Description
1 (NC)	4 (NC)	Normally closed relay contact; the contact is closed when the relay is switched off.
2 (COM)	5 (COM)	Common relay contact
3 (NO)	6 (NO)	Normally open relay contact; the contact is open when the relay is switched off.



Heavy loads directly connected to the battery can be switched using an additional power relay connected to the AUX 1 or AUX 2 outputs, e.g. via the Steca PA EV 200.

9.2.5 Temperature sensor connection TEMP (⑧ in Fig. 1)

If the controller and battery are not located in the same room then an external temperature sensor for measuring the battery temperature must be installed. We recommend using the optionally available Steca PA TS-S. Pin assignments:

Pin	7 (EXT.)	8 (GND)
Signal	Sensor connection ¹⁾	Sensor connection ¹⁾

¹⁾ Any polarity can be used.

9.2.6 Open UART interface, 3.3 V (⑦ in Fig. 1)

The open UART interface outputs the values measured by the controller. The interface can be switched on and off.

Interface protocol: see section 18.3.

Pin assignments:

Pin	9 (GND)	10 (TX)	11 (RX)
Signal	Battery minus	TX	RX

9.2.7 Function ground (⊕ in Fig. 1)



DANGER!

Risk of death by electrocution. Grounding causes the system to leave the safety extra-low voltage range. Protection against directly touching live components must be restored via appropriate isolation measures.



ATTENTION!

- The system voltage of thin-film modules must be positive to avoid corrosion. This requirement is satisfied in stand-alone systems that are *not* grounded.
- Danger of damaging the devices (e.g. computer) connected to the Master/Slave bus or the UART interface. *All* bus connections must be galvanically isolated when the system is grounded.



The controller does not need to be grounded in stand-alone systems. We recommend not grounding the controller. Also observe the local regulations.

If required, the controller can be grounded via the positive battery terminal '1+' ⊕ Bat+ Fig. 1 of the controller.

Observe the following:

- The connection point must lie between the external battery fuse and the controller.
- The connection point can be used as a common ground for all system components.
- Take the grounding of the entire system into account.



9.2.8 Operating buttons

The operating buttons have the following functions:

Button	Function
SET	<ul style="list-style-type: none"> ■ jumps down by one menu level ■ changes the state of a control element (check box/radio button) ■ causes the selected numeral to blink so that it can be modified ■ answers a query dialog with Yes ■ adopts a change
ESC	<ul style="list-style-type: none"> ■ jumps up by one menu level ■ jumps to the status display (press for 1 s) ■ answers a query dialog with No ■ discards any changes
△/▽	<ul style="list-style-type: none"> ■ moves the selection bar or the display content upwards/downwards ■ moves the selection 1 position to the left/right on a settings page ■ increases/reduces the setting value by 1 step ■ repeated button presses: press button for a longer time

9.3 Removing/installing the cover

9.3.1 Removing the cover

1.  Grip the cover with both hands as shown in Fig. 9.
2.  Use your index fingers to pull the edges slightly outwards and then pull upwards so that the cover is released from the end position.
3.  Pull off the cover entirely by lifting it upwards.

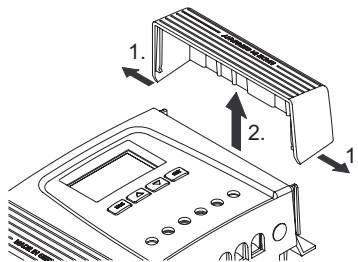

Fig. 9 Release the cover from the end position (here the right cover)

9.3.2 Installing the cover

1. ➔ Position the cover on the casing so that the two guide lugs on the cover fit into the guide slots in the casing.
2. ➔ Slide the cover onto the casing until it audibly latches into place.

9.4 Installing the device



ATTENTION!

Danger of damage to the controller and reduction of power. Observe the following safety requirements during installation:

- The mounting location and immediate environment are permanently fixed, vertical, flat, non-inflammable and not subject to constant vibration.
 - A free space of at least 60 mm must be present on all sides of the controller. The required free space relates to the controller *without* covers; see ② in Fig. 10.
 - The controller must be easily accessible and the display easily readable.
 - The controller is mounted as close as possible to the battery; the prescribed minimum safety clearance of 0.5 m between the controller and battery is adhered to.
 - The controller must not be located
 - outdoors or in a location subject to rain or splashing water,
 - in dusty environments,
 - in areas with active animal husbandry,
 - in direct sunlight.
 - The battery cable is no longer than 2 m (recommended), to keep cable losses and compensating voltage as low as possible.
 - Do not drill through the fastening openings ① (Fig. 10).
1. ➔ Select the mounting location under consideration of the previously mentioned safety requirements.
 2. ➔ Remove both controller covers.
 3. ➔ Position the controller level on the mounting surface and mark the mounting holes through the fastening openings ①.
 4. ➔ Remove the controller and drill the mounting holes.
 5. ➔ Use 4 suitable screws (max. M5) to fasten the controller to the mounting surface.
 6. ➔ Install the covers.

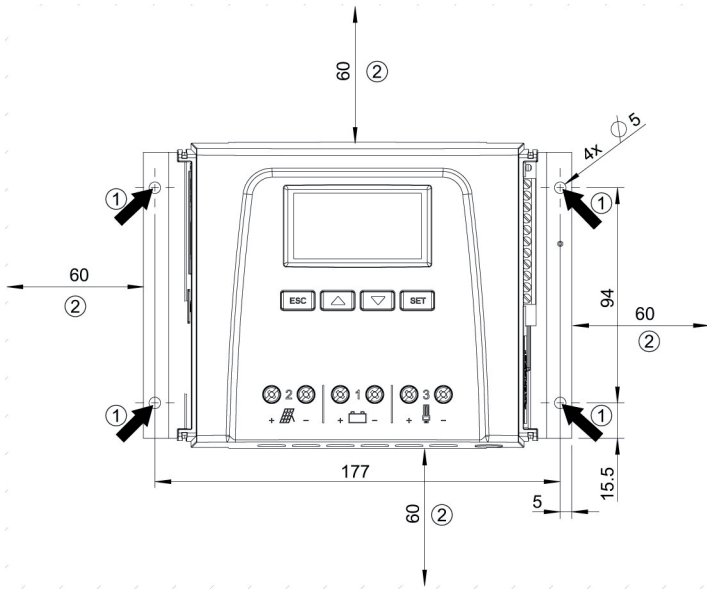

Fig. 10 Fastening openings ① and free space ②

9.5 Establishing the electrical connections

Always make connections in the following sequence:

CAUTION!

Always make connections in the following sequence:







1. First connect the load and then the source.

Example: First connect the cable to the controller and then to the battery.

2. Connect the positive pole first then the negative pole.

Example: First connect **B+** then **B-**.

9.5.1 Preparing the cables

1.  Label the cable ends as per Fig. 1 (M+, M-, B+, ...).
2.  Lay the battery, module and load cables directly next to each other. Do not yet connect the cables!
3.  Connect the external battery fuse, close to the battery and easily accessible, to the battery cable **B+** (❶ in Fig. 1).
4.  Switch off the external battery fuse: Remove the fuse insert from the fuse holder (safety fuse) or switch off the DC line circuit breaker and secure it against being switched on again.
5.  Connect the optional DC load circuit breaker, close to the controller and easily accessible, to the module cable **M+** (❷ in Fig. 1).
6.  Switch off the DC load circuit breaker and secure it against being switched on again.

9.5.2 Connecting the battery

- ✓ No devices are connected to the battery.







1. 



CAUTION!

Danger of damage to the controller. Observe the maximum battery voltage as per section 18.1.

Connect the battery cable and external battery fuse to the battery connection of the controller and to the battery.

2.  Switch on the external battery fuse: Insert the fuse insert into the fuse holder (safety fuse) or switch on the DC line circuit breaker. The controller automatically starts operation and, after a few seconds, displays the detected system voltage (= battery voltage) in an event message (Fig. 11).
3.  Note the system voltage displayed in Fig. 11.
4.  Press 'ESC' to confirm the event message. The basic setting display appears (Fig. 12).
5.  Confirm other event messages with 'ESC', e.g. 'RTC not set'.
6.  If Fig. 11 and Fig. 12 are not displayed then check the installation and if necessary correct the error using section 15.
7.  Check that the noted system voltage corresponds to the actual battery voltage. If not, set the system voltage in the expert menu ('Main menu' ► 'Battery settings' ► 'Expert menu' ► 'System voltage'; more information on this is provided in section 13.5).

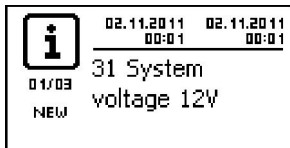

Fig. 11 Event message with the detected system voltage (in the example: 12 V)

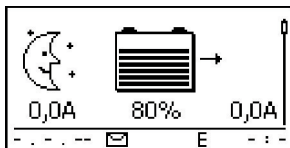

Fig. 12 Basic setting of the status display

i

The battery can be charged from multiple sources. The following applies:

- The battery can be charged by multiple controllers connected to the battery in parallel.
- Apart from the controller, other suitable charging sources can also be connected to the battery. These charging sources can be switched on and off by the controller via the 'AUX 1' and 'AUX 2' relay outputs.

9.5.3 Connecting the solar module

1. Safely cover the module (wind)
2. Connect the module cable and optional DC load circuit breaker to the solar module connection of the controller and to the solar module.
3. Remove covers from the solar module and, if present, switch on the DC load circuit breaker. The display shows Fig. 13 or Fig. 14.
4. If Fig. 13/Fig. 14 is not displayed, check the installation and if necessary correct the error on the basis of section 15.

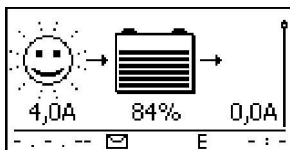

Fig. 13 Display with sunshine after connecting the solar module (possibly delayed)

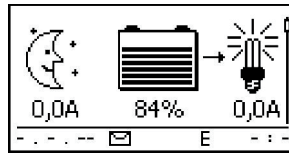

Fig. 14 Display without sunshine after connecting the solar module

9.5.4 Connecting loads



CAUTION!

- Danger of destroying the controller through overloading.
 - Loads that consume more current than can be supplied by the controller must be *directly* connected to the battery!
 - **Always directly connect** inverters to the battery!
- Danger of battery destruction due to deep discharging. Consumers that are not allowed to be switched off by the deep discharge protection of the controller (emergency lighting, radio link) must be directly connected to the battery and must not deeply discharge the battery.
- Danger of battery and cable destruction due to overloading. Directly connected loads must be separately fused.

1. ➔ Switch off the load output (section 13.5 'Switching loads on/off (load output)').
2. ➔ Connect the load cable to the loads and to the load output of the controller.
3. ➔ Switch on the load output. The lamp ① (Fig. 15) appears on the display.
4. ➔ Switch on the load. Load currents ② greater than 0.1 A are shown on the display.
5. ➔ If Fig. 15 is not displayed then check the installation and if necessary correct the error using section 15.

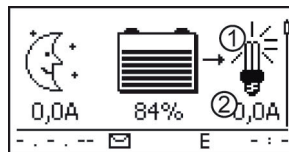

Fig. 15 Display content after connecting the load output

9.5.5 Connecting optional components

Installing cable strain relief

➔ Secure the cables with a strain relief clamp. Clearance to controller: 200 mm.

Connecting function ground

➔ Connect ground to positive battery terminal '1+' ① Bat+ Fig. 1 (observe section 9.2.7).

Installing lightning protection

➔ Install suitable lightning protection.

Connecting relay outputs 1 and 2



CAUTION!

Danger of destruction of the relays. Observe the technical data of the relays (section 18)!

1. ➔ Connect external components to the relay outputs 'AUX 1' und 'AUX 2'.

2. ➔ Configure the relay outputs as per section 14.

Connecting the external temperature sensor Steca PA TS-S

1. ➔ Install the temperature sensor Steca PA TS-S near to the battery.

2. ➔ Connect the sensor cable to contacts 7 ('EXT.') and 8 ('GND') (any polarity).

3. ➔ Set the temperature sensor under 'Main menu' ► 'Battery settings' ► 'Temperature sensor' to 'external'.

StecaLink bus: connecting master and slave devices

1. ➔ Set the addresses of suitable slave devices (observe section 9.2.1).



Maximum length of the Master bus cable: see section 18.2.

2. ➔ Connect the slave devices to the StecaLink bus.

3. ➔ Connect the StecaLink bus to the 'MASTER' RJ45 socket.

4. ➔ Connect the slave bus to the 'SLAVE IN' and 'SLAVE OUT' RJ45 sockets.

5. ➔ Terminate the last slave device according to the manufacturer's instructions.

Controller: plug optionally available termination plug into the open socket 'SLAVE IN' / 'SLAVE OUT' on the last controller.

Connecting the open UART interface

➔ Connect external devices to the open UART interface (observe in section 9.2.6).

Commissioning the microSD card





CAUTION!

Never forcibly insert or remove the microSD card. This can damage the card holder and/or the microSD card.



NOTICE

- A microSD card is not included in the scope of delivery for the device.
- microSD and microSDHC cards with a capacity of up to 8 GB can be used.
- The microSD card must be formatted with a FAT16 or FAT32 file system.
- Using the microSD card, the data of the device as well as of connected StecaLink slave devices can be recorded.
- Using the microSD card, setting parameters of the device can be saved and read in.
- Take care to observe the correct insertion direction, as shown on the microSD card and the device.
- Carefully and gently push the microSD card into the opening in the device casing until it latches into place.
- Remove the microSD card by pushing it towards the device until it unlatches, then let go of the card and, finally, pull the card out (Push-Pull connector).
- Data recording onto the SD card is deactivated at the factory.

1.  Insert a formatted microSD card.
2.  Configure the data logging function and save/load the parameters as described in section 14.3.10 'SD card'.

10 Performing initial commissioning



ATTENTION!

Danger of damage to the device and reduction of power. Only technical professionals may perform the work described in this section.

- ✓ All the measures described in section 9.4 and section 9.5 have been completed.

Showing the basic setting of the status display

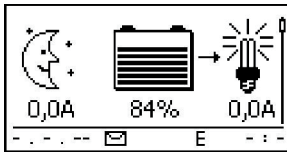

- ▶ If necessary, press 'ESC' for 1 s to show the basic setting of the status display.

Setting the language

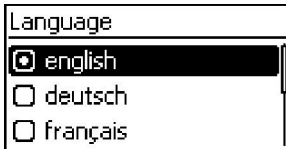
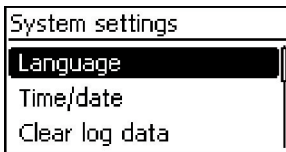
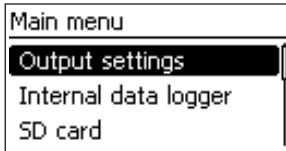

1. Press 'SET'. The main menu appears and the 'Output settings' entry is selected (Fig. left).

Note

English is set as the default menu language at the factory

2. Press ∇ 3 times to select 'System settings'.
3. Press 'SET'. The 'System settings' menu appears and 'Language' is selected (Fig. left).
4. Press 'SET'. The 'Language' menu appears (Fig. left).
5. Press $\Delta \nabla$ to select a different language.
6. Press 'SET'.

Setting the time

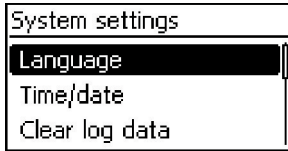

1. Press 'ESC'. The 'System settings' menu appears (Fig. left).
2. Press ▾ to select 'Time/date'.
3. Press 'SET'. The 'Time/date' menu appears and 'Time' is selected.
4. Press 'SET'. The 'Time setting' dialog appears (Fig. left).
5. Press 'SET'. The hour flashes.
6. Press ▴▾ to change the hour.
7. Press 'SET'. The hour stops flashing.
8. Press ▾. The minutes are selected.
9. Repeat steps 5 to 7 for setting the minutes.

Setting the date

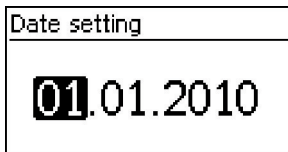

1. Press 'ESC'. The 'Time/date' menu appears.
2. Press ▾ to select 'Date'.
3. Press 'SET'. The 'Date setting' dialog appears (Fig. left).
4. Press 'SET'. The day flashes.
5. Press ▾▴ to change the day.
6. Press 'SET'. The day stops flashing.
7. Press ▾ to select the month.
8. Repeat steps 4 to 6 for setting the month.
9. Press ▾ to select the year.
10. Repeat steps 4 to 6 for setting the year.

Setting the battery type

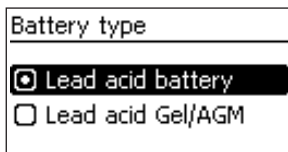

1. Press 'ESC' for 1 s. The basic setting display appears
2. Press 'SET'. The main menu appears.
3. Press ▾ to select 'Battery settings'.
4. Press 'SET'. The 'Battery settings' menu appears.
5. Press ▾ to select 'Battery type'.
6. Press 'SET'. The 'Battery type' dialog appears (Fig. left).
7. Press ▾▴ to select a different battery type.
8. Press 'SET'. The selected battery type is set.

Setting the battery capacity

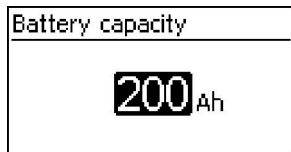

1. Press 'ESC'. The 'Battery settings' menu appears.
2. Press ▾ to select 'Battery capacity'.
3. Press 'SET'. The 'Battery capacity' dialog appears (Fig. left).
4. Press 'SET'.
5. Press ▾△ to change the value.
6. Press 'SET'. The value stops flashing.

Setting the control mode

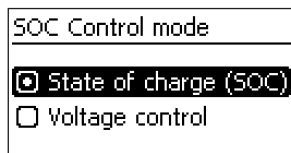

Note

The control mode 'State of charge (SOC)' is preset at the factory and only needs to be changed if required. More information on this is provided in section 12.2.

1. Press 'ESC'. The 'Battery settings' menu appears.
2. Press ▾ to select 'Battery control mode'.
3. Press 'SET', the 'SOC Control mode' dialogue appears.
4. Press ▾△ to select 'Voltage control'.
5. Press 'SET'. The voltage control is set.

Switching off cable compensation

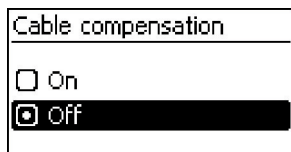
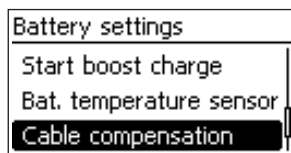

Note

Cable compensation is switched on at the factory and only needs to be switched off if required. More information on this is provided in section 12.2.

1. Press 'ESC'. The 'Battery settings' menu appears.
2. Press ▾△ to select 'Cable compensation'.
3. Press SET. The 'Cable compensation' dialog appears.
4. Press ▾△ to select 'Off'.
5. Press 'SET'. Cable compensation is switched off (Fig. left).

Finishing initial commissioning

- ▶ Press 'ESC' for 1 s. The basic setting of the status display appears and initial commissioning is finished.

Note

You can usually now use the controller without making any further settings. For information on important additional functions see section 14.

11 Dismounting the controller



DANGER!

Risk of death by electrocution. Only technical professionals may perform the work described in this section. Observe the warning notes in section 9.1.



WARNING!

Danger from hot surfaces. Allow the heatsink on the rear of the device to cool down before touching.

Disconnecting the loads from the controller

1. Switch off all loads.
2. Disconnect the load cables **L-** and **L+** from the controller.

Disconnecting the solar module from the controller

3. If present, Switch off the DC load circuit breaker (solar module) and secure it against being switched on again or Safely cover the module (wind).
4. Disconnect the module cables **M-** and **M+** from the controller and insulate the cable ends

Disconnecting the battery from the controller

5. Switch off the external battery fuse: Remove the fuse insert from the fuse holder (safety fuse) or switch off the DC line circuit breaker and secure it against being switched on again.
6. Disconnect the battery cables **B-** and **B+** from the controller and insulate the cable ends.

Finishing dismounting

7. If present, disconnect any remaining components from the controller (buses, sensors etc.).
8. Remove the controller from the mounting surface.

12 System functions

12.1 Protection functions

12.1.1 Controller overload

The controller is protected from the following faults and is not damaged when these faults occur *individually*.

- Solar module *or* battery *or* load connected with the wrong polarity
- Solar module *or* battery *or* load incorrectly connected
- Solar module *or* load short-circuited
- Battery not connected

Once the individual fault has been corrected the controller will operate correctly without taking any further measures.



ATTENTION!

The following faults damage the controller:

- At least 2 of the above mentioned faults occur *simultaneously*.
- The load outputs of multiple controllers are connected in parallel.
- A solar module is connected to multiple controllers in parallel.



If the battery voltage drops below 9.5 VDC, safe operation of the controller can no longer be guaranteed. The controller stops all functions, especially charging of the battery.

12.1.2 Overheating of the controller

The cooling fins on the rear side and the internal temperature controller prevent the controller from overheating. If the controller becomes too hot then the battery is no longer charged and the load output is also switched off if necessary.

12.1.3 Deep discharging of the battery

To protect the battery from deep discharge the controller switches off the load output and the 'AUX 1' and 'AUX 2' relay outputs if necessary. More information on this is provided in section 14.

12.2 Control mode

The controller has 2 control modes:

- Based on the actual state of charge of the battery (SOC control)
- Based on the battery voltage (voltage control)



The use of the SOC control is strongly recommended because a longer battery life can be expected by using it.

When *SOC control* is switched on the charge state of the battery is displayed in percent, with *Voltage control* the charge state is displayed in volts. The following applies in addition:

- If components are connected directly to the battery, the controller can only determine the SOC correctly if it measures the battery currents with device-specific Steca current sensor PA HS400. If it is not possible to measure the battery currents, the controller must be changed to *Voltage control*.
- The controller takes the battery temperature into account for accurate determination of the charge completion voltage. To do this, the controller measures the room temperature using its own internal temperature sensor and assumes that the battery is also at room temperature. If the battery is located in a different room than the external temperature sensor Steca PA TS-S (optional) should be used.
- The voltage drop in the battery cables distorts the battery voltage measurement of the battery and, thus, the actual charging voltage present at the battery. The cable compensation of the controller compensates for this voltage drop. Additional sensors are not required. Cable compensation is switched on in the factory settings.

Operation

- Control mode: 'Main menu' ► 'Battery settings' ► 'Battery control mode'
- Temperature sensor: 'Main menu' ► 'Battery settings' ► 'Temperature sensor Bat.'
- Cable compensation: 'Main menu' ► 'Battery settings' ► 'Cable compensation'

12.3 Battery charging functions

12.3.1 Float charging

When the battery is fully charged, the controller automatically switches to float charging (charging with the float charge voltage). This prevents the battery from being discharged.



ATTENTION!

The float charging voltage must be set according to the specifications of the battery manufacturer to ensure optimum charging of the battery.

Operation

Float charging voltage: *'Main menu' ► 'Battery settings' ► 'Charge voltages' ► 'Float charging'*

12.3.2 Boost charging

Boost charging provides more intensive care of the battery than float charging. The following applies in addition:

- Boost charging starts when the switch-on threshold¹⁾ is reached. Boost charging can also be started manually.
- Boost charging stops after the charge duration has expired.
- With boost charging the charging voltage is higher than with float charging.
- After boost charging the controller automatically switches to float charging.



Observe the manufacturer's specifications when setting the charge duration and charge completion voltage.

Operation

- Switch-on threshold: *'Main menu' ► 'Battery settings' ► 'Charge voltages' ► 'Boost charging' ► 'Starting threshold'*
- Charge duration: *'Main menu' ► 'Battery settings' ► 'Expert menu' ²⁾ ► 'Boost charge dur.'*
- Charge completion voltage: *'Main menu' ► 'Battery settings' ► 'Charge voltages' ► 'Boost charging' ► 'Boost charge voltage'*
- Starting boost charging manually: *'Main menu' ► 'Battery settings' ► 'Start boost charge'*

¹⁾ Value in *percent* with SOC control, in *volts* with voltage control

²⁾ More information on this is provided in section 13.5 'Calling up the expert menu for battery settings'.

12.3.3 Equalise charging

Equalise charging prevents acid layering via controlled gassing and thus extends the service life of the battery. The following applies in addition:

- Equalise charging starts when the cycle has expired or the switch-on threshold¹⁾ is crossed.
- Equalise charging stops after the charge duration has expired.
- Equalise charging is switched on in the factory settings. Prerequisite: battery type = *'Lead acid battery'*.
- After equalise charging, the controller automatically changes to float charging.



- Observe the manufacturer's specifications when setting the cycle and charge duration.
- Equalise charging is only possible if the battery type *'Lead acid battery'* is set.

Operation

- Generally switching equalise charging on/off: *'Main menu' ▶ 'Battery settings' ▶ 'Equal. charging cycle' ▶ 'On/off'*
- Cycle: *'Main menu' ▶ 'Battery settings' ▶ 'Equal. charging cycle' ▶ 'Cycle duration'*
- Switch-on threshold: *'Main menu' ▶ 'Battery settings' ▶ 'Charge voltages' ▶ 'Equal. charging' ▶ 'Starting threshold'*
- Charge completion voltage: *'Main menu' ▶ 'Battery settings' ▶ 'Charge voltages' ▶ 'Equal. charging' ▶ 'Equal. charging voltage'*
- Battery type: *'Main menu' ▶ 'Battery settings' ▶ 'Battery type'*
- Charge duration: *'Main menu' ▶ 'Battery settings' ▶ 'Expert menu' ²⁾ ▶ 'Equal. charge dur.'*

¹⁾ Value in *percent* with SOC control, in *volts* with voltage control

²⁾ More information on this is provided in section 13.5 'Calling up the expert menu for battery settings'.

12.4 Data logger

The data logger stores the following data in internal memory:

- Energy input
- Energy output
- Min. battery voltage
- Max. battery voltage
- Max. input current
- Max. load current

Internally stored data is shown on the display and can be deleted.

13 Display (layout, function, operation)

13.1 Overview (menu structure)

An overview of the operating structure of the display is provided on section 8.

13.2 Status display

The status display consists of the *Basic setting*, the pages with the *Measurements* and the *Information bar*.

Basic setting

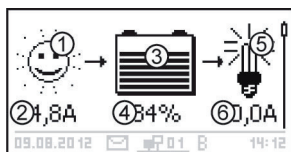

- ① The *Solar module/system* symbol shows the status of the solar module and the system as follows:



The solar module is illuminated and the controller has detected the *Day* condition. No event message or a message of type *Information*¹⁾ is present.



The solar module is illuminated and the controller has detected the *Day* condition. An event message of type *Warning*¹⁾ or *Error*¹⁾ is present.



The solar module is not illuminated and the controller has detected the *Night* condition. No event message or a message of type *Information*¹⁾ is present.



The solar module is not illuminated and the controller has detected the *Night* condition. An event message of type *Warning*¹⁾ or *Error*¹⁾ is present.

- ② Input current in amperes
 ③ The *Battery* symbol indicates charging of the battery as follows:



Battery almost full



Battery almost empty

- ④ Charge state of the battery in % or volts.
 With *SOC control*: Charge state in %
 With *voltage control*: Battery voltage in volts
 ⑤  The *Load* symbol is shown when the load output is switched on.
 ⑥ Load current in amperes

¹⁾ More information on this is provided in section 15.1.

Measured values

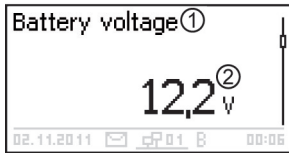

- ① Name of the measured value
- ② Measurement with units

The following measurements are displayed:

- Battery voltage
- SOC: battery state of charge in % (only shown in SOC control)
- PV current: presently available max. module current
- Input current: amount of PV current that is actually being used.
- Charge/discharge current:
Positive = current flowing from controller to battery
Negative = current flowing from battery to controller
- Load current: current from the controller to the loads
- Daily input¹⁾: the daily energy supplied by the modules
- Daily load¹⁾: the daily energy supplied to loads (connected to the controller)
- Device temperature
- Battery temperature
- Remaining battery capacity (usable)

Note

As the battery capacity changes over time, the displayed remaining capacity may deviate from the actual remaining capacity.

- Operating hours
-

i

The following display of information on currents of additional StecaLink slave devices (only on the master): extent and designation of the representation depends on the respective slave and its settings.

- Total charge/discharge current of the battery: total of all currents of the components that have been activated in the menu *'Battery settings' ► 'Battery control mode' ► 'Sensor member list'*. Display of the current median in A.

¹⁾ Generators/loads that are not connected directly to the device must be covered by the device specific Steca current sensor PA HS400 to allow for correct values to be displayed (depending on the sensors selected in the data logger).

- Total discharge current of the battery: total of all battery discharge currents of the components that have been activated in the menu 'Battery settings' ► 'Battery control mode' ► 'Sensor member list'. Display of the current median in A.
- Total charge current of the battery: total of all battery charge currents of the components that have been activated in the menu 'Battery settings' ► 'Battery control mode' ► 'Sensor member list'. Display of the current median in A.

Attention

The controller is not approved as a calibrated measuring device.

Information bar

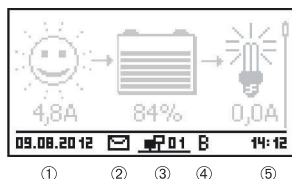

- ① Date
- ② Symbol for unacknowledged event messages; more information on this is provided in section 15.1.
- ③ *Connect* symbol with 2-digit StecaLink slave address; indicates data traffic on the StecaLink bus.
- ④ Symbol for the charging function being executed at the moment:
 - 'E' (equalise charge)
 - 'F' (float charge)
 - 'B' (boost charge)
 - 'S' (StecaLink slave mode active)
- ⑤ Time

13.3 Display of special states

- When the inverter is processing large amounts of data it is not able to process any user input. This is indicated by an animated sun symbol: ☼
- The backlight flashes red when faults occur. An event message is also displayed.
- The display can also temporarily malfunction when the controller is operated outside the permissible temperature range.

13.4 General operation

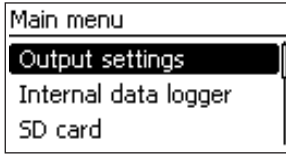

1. If necessary, press 'ESC' for 1 s to show the basic setting of the status display.
2. Press $\nabla\Delta$ to display the measurements.
3. Press 'SET'. The main menu is displayed with the top item selected.
4. Press $\nabla\Delta$ to select a different entry (Fig. left).
5. Press 'SET'. The submenu appears.
6. Repeat steps 4 and 5 if necessary.
7. Press 'ESC' briefly to jump one menu level higher or press 'ESC' for a longer time (1 s) to show the basic setting display.

13.5 Advanced operation

Switching loads on/off (load output)

✓ 'Main menu' ► 'Output settings' ► 'Load' ► 'Operation mode'

1. Press $\nabla\Delta$ to select 'On' or 'Off'.
2. Press 'SET'. The load output is switched on/off.

Displaying advanced information

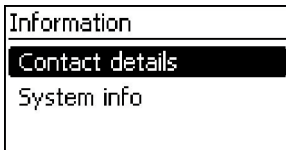

✓ 'Main menu' ► 'Information'

1. Press $\nabla\Delta$ to select an entry (Fig. left).
2. Press 'SET' to open the entry.

The entries contain the following information:

- 'Contact details': manufacturer address as text and QR code.
- 'System info' (Fig. left):

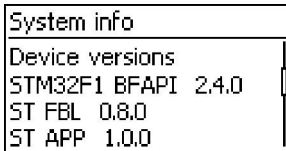

- Product designation
- Serial number
- Version of the software modules
- Address of the controller on the Slave bus
- Version of the manual for the inverter

Calling up the expert menu for battery settings



ATTENTION!

Risk of damaging the system. The expert menu allows modification of settings that require specialist technical knowledge. The expert menu must therefore only be used by professional personnel who know the applicable regulations and standards.



✓ 'Main menu' ► 'Battery settings' ► 'Expert menu'

1. Press 'SET'. The password entry dialog is displayed and the 1st character from the left is selected (Fig. left).

Note

The password is 17038.

2. Press 'SET'.
3. Set '1' with ∇/Δ and confirm with 'SET'.
4. Press ∇ to select the 2nd digit from the left.
5. Press 'SET'.
6. Set '7' with ∇/Δ and confirm with 'SET'.
7. Repeat steps 4 to 6 for the other digits.
8. Press 'SET' for 1 s. The expert menu is displayed (Fig. left).
9. Press ∇/Δ to select an entry.
10. Press 'SET' to open the entry.

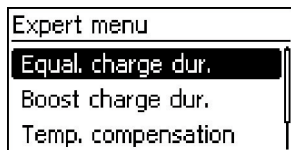

14 Control functions

14.1 Overview

The load output and relay outputs can be automatically switched by the following control functions:

- Morning light function
- Evening light function
- Night light function
- Excess energy control
- Generator manager
- Alarm (AUX 1 and AUX 2 only)
- Timer 1 ... 4

The following applies to the control functions:

- The operating mode can be set for each output ('On' /'Off' /'Function controlled').
- An individual switch-off threshold for deep discharge protection of the battery can be set for each output.
- When a control function is switched off its setting is retained.
- The switching times and thresholds of the control functions can be individually set for each output.
- The control functions for an output are logically ORed. This means:
 - Each control function can switch on the output independently of the other control functions.
 - The output is switched off when *all* control functions have switched it off, or the deep discharge protection is active for this output.

14.2 Operation

The control functions are set for each output using the following steps:

Setting the operating mode

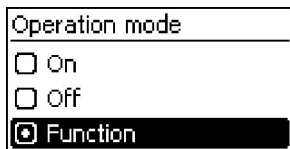
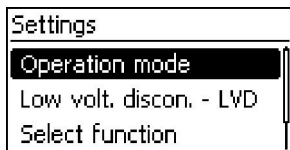
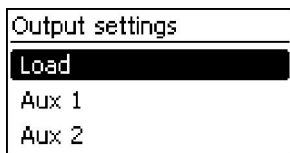

✓ 'Main menu' ► 'Output settings'

1. Select an output in the 'Output settings' window (Fig. left).
2. Press 'SET'. The menu for setting the output appears, 'Operation mode' is selected (Fig. left).
3. Press 'SET'. The option fields for setting the operating mode are displayed.

Note

The load output is switched on in the factory settings (operating mode = 'On').

4. Press $\nabla\Delta$ to select an option field:
'On': the output is switched on.
'Off': the output is switched off.
'Function': the control functions automatically switch the output.
5. Press 'SET'. The selected operating mode is switched on (Fig. left).
6. Press 'ESC' to leave the page.

Setting the deep discharge protection

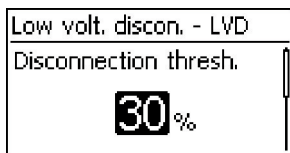

✓ 'Main menu' ► 'Output settings' ► <Output> ► 'Low volt. discon. - LVD'

1. Press 'SET'. The switch-off threshold is displayed (Fig. left).
2. Use $\nabla\Delta$ to set the switch-off threshold and confirm with 'SET'.

Note

A value $\geq 30\%$ is recommended

3. Press ∇ . The switch-on difference is shown.
4. Press 'SET', use $\nabla\Delta$ to set the switch-on difference and confirm with 'SET'.
5. Press 'ESC' to leave the page.

Switching control functions individually on and off

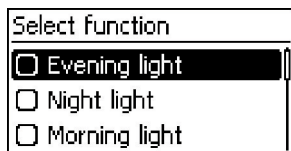

✓ 'Main menu' ► 'Output settings' ► <Output> ► 'Select function'

1. Press $\nabla\Delta$ and 'SET' to switch the control functions on and off (Fig. left).

Note

The switched-on control functions only take effect in the 'Function' operating mode.

2. Press 'ESC' to leave the page.

Setting control functions



Setting of the control functions is described below using Evening light and 'Timer 1' as examples.

Setting the evening light

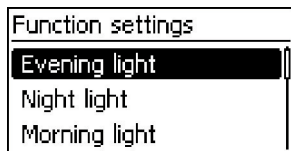

✓ 'Main menu' ► 'Output settings' ► <Output> ► 'Function settings'

1. Press $\nabla\Delta$ as required to select 'Evening light' (Fig. left).

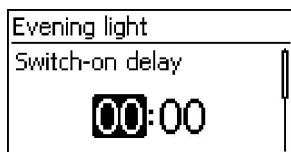

2. Press 'SET'. The 'Switch-on delay' dialog appears (Fig. left).
3. Press 'SET', use $\nabla\Delta$ to set the switch-on delay hours and confirm with 'SET'.
4. Press ∇ . The minutes are selected.
5. Press 'SET', use $\nabla\Delta$ to set the minutes and confirm with 'SET'.
6. Press ∇ . The 'Switch-on duration' dialog appears.
7. Press 'SET', repeat steps 3 to 5 for the switch-on duration.
8. Press 'SET'. The 'Function settings' menu appears.

Setting Timer 1

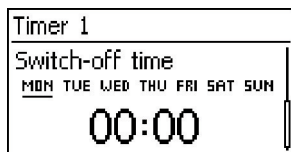
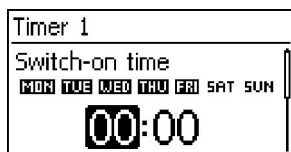

1. Select 'Timer 1'.
2. Press 'SET'. The 'Switch-on time' dialog appears and the selected day is underlined (Fig. left: Monday is selected and switched off).
3. Press $\nabla\Delta$ to select a different day.
4. Press 'SET'. The state of the selected day changes (Fig. left: Monday is switched on).
5. Press $\nabla\Delta$ to select a different day.
6. Repeat steps 4 to 5 until all days are switched on for which the switch-on time is to apply.
7. Press ∇ (several times if necessary) until the hour of the switch-on time is selected (Fig. left).
8. Press 'SET', use $\nabla\Delta$ to set the hours and confirm with 'SET'.
9. Press ∇ . The minutes are selected.
10. Press 'SET', use $\nabla\Delta$ to set the minutes and confirm with 'SET'.
11. Press ∇ . The 'Switch-off time' dialog appears (Fig. left).
12. Set the day and time of the switch-off time in the same manner as described in steps 3 to 10.
13. The *Evening light* and *Timer 1* control functions have now been set. Press 'ESC' to leave the page.

14.3 Functionality

i

With all brightness-based control functions, the required brightness information is obtained from the solar module.

14.3.1 Deep discharge protection

Switching behaviour

The deep discharge protection switches the output off below the switch-off threshold and enables it again when the battery charge exceeds the switch-off threshold by the switch-on difference (similar functionality to section 14.3.5 "StecaLink master connection").

Operation

'Main menu' ► 'Output settings' ► <Output> ► 'Low volt. discon. - LVD'

14.3.2 Morning light function

The morning light function switches the output on and off based on the brightness and time. The reference point is the time of dawn. The morning light function is suitable for loads that are operated a certain time before dawn, e.g. heating, feeding system, bus-stop lighting.

Switching behaviour

- The output remains switched on during the switch-on duration ⑤ (Fig. below) and is switched off by the switch-off duration ⑥ before dawn.
- When dawn is detected the output is switched off, even if the switch-on duration has not expired.



The morning light function relates to the time of dawn, but the resulting switching time lies before dawn, i.e. in the past. For this reason, the controller must have performed at least one night-day changeover before the morning light function can be executed. After this, the controller continuously adjusts the time of dawn to suit any changes (weather, annual changes to the length of the day, disconnection/covering of the solar module).

Operation

'Main menu' ► 'Output settings' ► <Output> ► 'Select function'

'Main menu' ► 'Output settings' ► <Output> ► 'Function settings' ► 'Morning light'

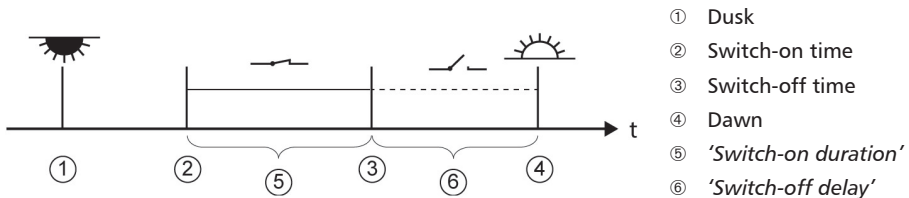

14.3.3 Evening light function

The evening light function switches the output on and off based on the brightness and time. The reference point is the time of dusk. The evening light function is suitable for loads that are operated a certain time after nightfall, e.g. lighting, heating.

Switching behaviour

- The output remains switched on during the switch-on duration ⑥ (Fig. below) but the switch-on is delayed by the switch-on delay ⑤.
- When dawn is detected the output is switched off, even if the switch-on duration has not expired.

Operation

'Main menu' ▶ 'Output settings' ▶ <Output> ▶ 'Select function'

'Main menu' ▶ 'Output settings' ▶ <Output> ▶ 'Function settings' ▶ 'Evening light'

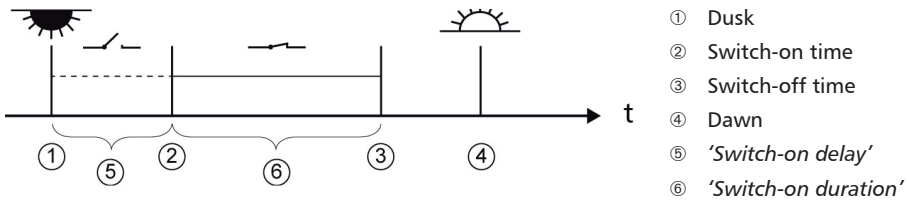

14.3.4 Night light function

The night light function switches the output on and off based on the brightness and time. The reference points are the times of dusk and dawn. The night light function is suitable for loads that are only operated at night, e.g. emergency lighting.

Switching behaviour

The output is switched on at the switch-on delay ⑤ (Fig. below) after dusk and switched off at the switch-off delay ⑦ before dawn. For the *Dawn time* see note in section 14.3.2.

Operation

'Main menu' ▶ 'Output settings' ▶ <Output> ▶ 'Select function'

'Main menu' ▶ 'Output settings' ▶ <Output> ▶ 'Function settings' ▶ 'Night light'

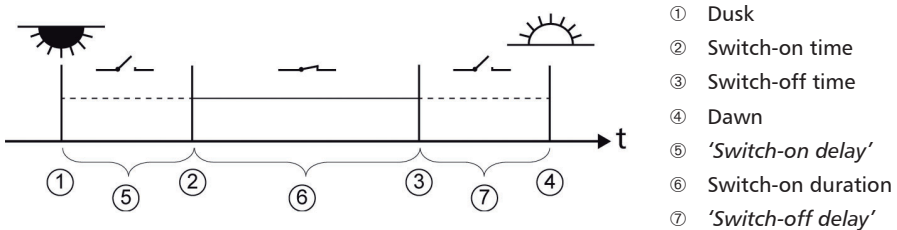

14.3.5 Excess energy control

Excess energy control switches the output on as long as the battery has a high state of charge¹⁾. Excess energy control is suitable for non time-critical loads that can be specifically switched on when a surplus of energy is available, e.g. electric water heating, pumping station for filling an elevated water tank.

¹⁾ Value in *volts* with voltage control and in *percent* with SOC control

Switching behaviour

The output is switched on when the switch-on threshold ① is reached (Fig. below) and is switched off when the charge state drops the switch-off difference ② (hysteresis) below the switch-on threshold.

Operation

'Main menu' ▶ 'Output settings' ▶ <Output> ▶ 'Select function'

'Main menu' ▶ 'Output settings' ▶ <Output> ▶ 'Function settings' ▶ 'Excess energy contr.'

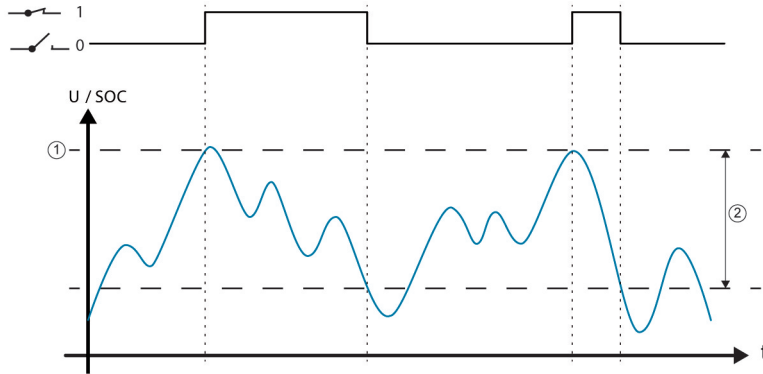

① 'Starting threshold'

② 'Hysteresis'

14.3.6 Generator manager

The generator manager switches the output on as long as the battery has a low state of charge¹⁾. The generator manager is suitable for a generator that is switched on when the battery is at a low state of charge.

¹⁾ Value in *volts* with voltage control and in *percent* with SOC control.

Switching behaviour

The output is switched on when the switch-on threshold ① is reached (Fig. below) and is switched off when the charge state reaches the switch-off difference ② (hysteresis) above the switch-on threshold.

Operation

'Main menu' ► 'Output settings' ► <Output> ► 'Select function'

'Main menu' ► 'Output settings' ► <Output> ► 'Function settings' ► 'Generator manager'

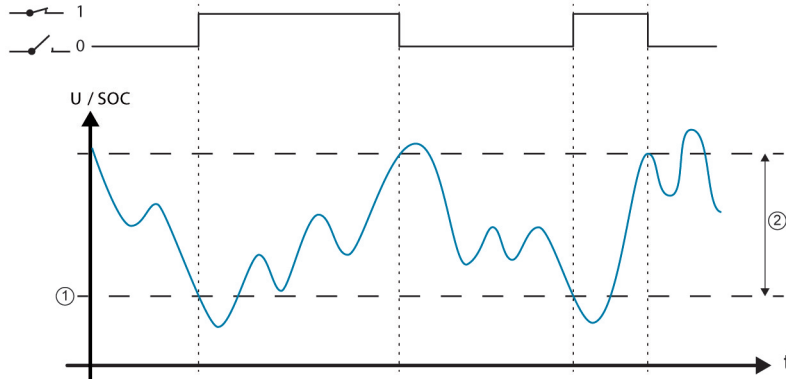

① 'Starting threshold'

② 'Hysteresis'

14.3.7 Alarm

The alarm switches the 'AUX 1' and 'AUX 2' on as long as one of the selected event messages is present.

Operation

'Main menu' ► 'Output settings' ► <Output> ► 'Select function'

'Main menu' ► 'Output settings' ► <Output> ► 'Function settings' ► 'Alarm'

14.3.8 Timer 1 ... 4

The timers can be used to switch the outputs on and off at specific times in a weekly cycle. The switch-on and switch-off times for each weekday can be separately defined for each timer.

Switching behaviour

The weekdays for the on and off switching times are set independently; which means that the duration of an on or off time can stretch over several days.

Operation

'Main menu' ► 'Output settings' ► <Output> ► 'Select function'

'Main menu' ► 'Output settings' ► <Output> ► 'Function settings' ► 'Timer 1 - 4'

14.3.9 StecaLink bus



NOTICE!

- The StecaLink bus is an RS-485 communication interface that uses a special Steca transmission protocol.
- Various different StecaLink-compatible devices can be networked together via the StecaLink bus.
- Data exchange and/or remote function execution are possible via the StecaLink bus, depending on the respective StecaLink member device.
- For information on connecting StecaLink member devices to the controller, see section 9.2.1 'StecaLink slave connection'.
- Please visit www.steca.com for continuously updated documentation on the compatible StecaLink devices and the software versions required.

14.3.9.1 StecaLink slave address setting

StecaLink slave address

Notices

- Setting of the device address used for identifying the device as a StecaLink slave node.
- Within a StecaLink communication network each slave device must have a unique device address.
- Problems/error messages will occur during device registration if multiple devices have the same address.
- ✓ *'Main menu ► System settings ► StecaLink slave addr.'*

RS485 address

1

1. Press 'SET'. The 'RS485 address' dialogue appears (Fig. left).
2. Press 'SET'. The value flashes.
3. Press Δ , ∇ to change the value.
4. Press 'SET'. The value stops blinking.

14.3.9.2 StecaLink master setting



NOTICE!

- The master device in a StecaLink communication network controls the flow of data to the StecaLink slave members.
- The StecaLink slave members must be registered at the master device. Configuration of the slaves must be performed at the master, depending on the type and functional scope of each respective slave.
- See section 9.2.2 'StecaLink master connection'.

Adding a slave device

Set slave address
No slave found 1

Set slave address
HS400 49

- ✓ 'Main menu' ► 'System settings' ► 'StecaLink master menu' ► 'Add slave device'

1. Press 'SET'. The Set slave address dialogue appears (Fig. left).
2. Press 'SET'. The value flashes
3. Press Δ , ∇ to change the value.
4. Press 'SET'. The value stops blinking. The StecaLink master queries the entered address. The detected StecaLink slave member is displayed (Fig. left).
5. Press 'SET'. If additional settings for the registered slave are possible then an additional menu is displayed.

For information on the further configuration parameters, see 'Changing slave settings'.

'No slave found' – a StecaLink member device could not be identified at the specified address. See Chapter 15 'Troubleshooting' for possible error correction measures (see event message - Number 79).

'Address already used' - a StecaLink member device is already registered under the specified address, see section 15 'Troubleshooting' for possible error correction measures (see event message - Number 79).

Changing slave settings

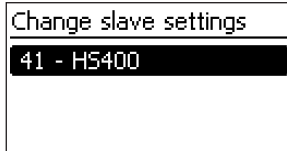

Notices

- Here, the device-specific settings of the slaves registered on the controller can be set.
- Different settings are available depending on the functional scope of the slave.
- ✓ 'Main menu' ► 'System settings' ► 'StecaLink master menu' ► 'Change slave settings'

1. Press 'SET'. The 'Change slave settings' dialogue appears with a list of the recognized StecaLink slave members. The list is sorted by increasing order of the member addresses (Fig left).
2. Press Δ , ∇ to select the StecaLink slave member whose settings are to be changed.
3. Press 'SET'. The configuration menu for the selected slave appears.

Further information on the individual configuration settings for each respective slave is provided in the operating instructions for the slave.

In the operating instructions for the PA HS400 current sensor.

14.3.9.3 Changing the slave settings

Selecting the slave

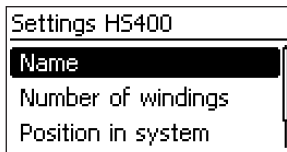
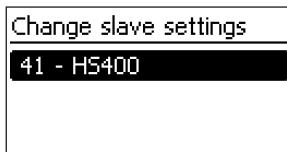

- ✓ 'Main menu' ► 'System settings' ► 'StecaLink master menu' ► 'Change slave settings'

1. Press 'SET'. The 'Change slave settings' dialogue appears with a list of the recognised StecaLink slave members. The list is sorted by increasing order of the member addresses (Fig left).
2. Press Δ , ∇ to select the slave whose settings are to be changed.
3. Press 'SET'. The 'Settings slave' dialogue appears, with the configuration menu for the slave (Fig. left).

Changing slave settings

Name

Notices

- An individual name can be assigned to each StecaLink slave.
- Assignment of a name is optional and is not required for operating the device.
- The name is shown in the measurements display on the status screen.
- The following printable ASCII characters can be used for entering an individual name: !"#%&'()*+,-./0123456789:;<=>?@ABCDEFGHIJKLMNPOQRSTUVWXYZ[\]^_`abcdefghijklmnopqrstuvwxyz{|}~
- An individual name with a length of up to 8 characters can be entered.
- ✓ 'Main menu' ► 'System settings' ► 'StecaLink master menu' ► 'Change slave settings' ► Selection of the slave is displayed ► 'Name'

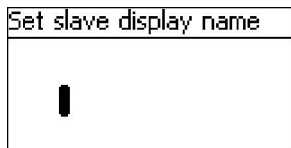

1. Press 'SET'. The 'Set slave display name' dialogue appears (Fig. left).
2. Press Δ , ∇ to select the character position.
3. Press 'SET'. The entry position blinks.
4. Press Δ , ∇ to select the desired character.
5. Press 'SET'. The entry position stops blinking

The selected character is adopted

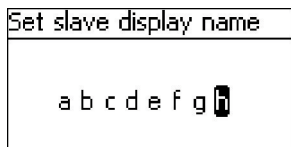

6. Repeat steps 2.-5. until the desired name with max. 8 characters has been entered (Fig. left).
7. Press 'SET' to exit the data entry dialogue.

Delete slave



NOTICE!

- StecaLink slave members can be deleted to remove them from the communications network.
- This is necessary when StecaLink slave members have been removed or their slave address has been changed.
- Display and data logging data is no longer exchanged with a StecaLink slave member after it has been deleted.
- Deleted slave members are removed from all other relevant configuration lists in the Tarom Masters.

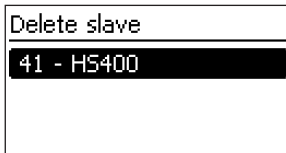

- ✓ *'Main menu' ▶ 'System settings' ▶ 'StecaLink master menu' ▶ 'Delete slave'*

1. Press *'SET'*. The *'Delete slave'* dialogue appears with a list of the recognised StecaLink slave members. The list is sorted by increasing order of the member addresses (Fig. left).
2. Press Δ , ∇ to select the StecaLink slave member to be deleted.
3. Press *'SET'*. The *'Delete slave'* dialogue appears (Fig. left).
4. Hold *'SET'* pressed for 1 s. The selected slave is deleted.

14.3.10 SD card



NOTICE

- For information on handling the SD card, see 'Commissioning the microSD card' in section 9.5.5.
- With the aid of the SD card, settings parameters of the Tarom 4545 / 4545-48 can be saved and loaded again.
- Various different measurements, states and events can be stored on the SD card.
- When data logging is activated, the data is recorded in separate files for each Tarom master device.

Datalogger On/Off

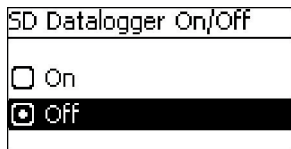

Loading parameters

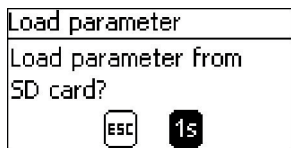

Storing parameters

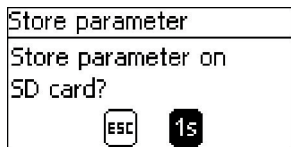

Notices

- Data logging to the SD card can only be generally switched on and off.
 - Any existing data files are not deleted. Information is appended to existing files.
 - ✓ 'Main menu' ► 'SD card' ► 'Datalogger On/Off'
1. Press 'SET'. The 'SD Datalogger On/Off' dialogue appears (Fig. left).
 2. Press Δ , ∇ to change the selection.
 3. Press 'SET'. The selection is adopted.

Notices

- Only the entire set of parameters can be loaded.
 - The applicable set of valid parameters must be stored in a file with the name 'Master.ini'.
 - Selection between various different parameter sets is not possible.
 - ✓ 'Main menu' ► 'SD card' ► 'Load parameter'
1. Press 'SET'. The 'Load parameter' dialogue appears (Fig. left).
 2. Press 'SET' for 1 s. Then, the parameters are loaded from the SD card and accepted in the Taron's settings.

Notices

- Any existing file is replaced when the parameter file is stored.
 - The file name used for the parameter files is not configurable.
 - ✓ 'Main menu' ► 'SD card' ► 'Store parameter'
1. Press 'SET'. The 'Store parameter' dialogue appears (Fig. left).
 2. Press 'SET' for 1 s. The parameters are then stored on the SD card.

15 Troubleshooting

Errors detected by the controller are indicated via event messages. With *Warning* and *Error* events the display flashes red. Information on correcting errors is provided in section 15.1 "List of event messages".

15.1 Event messages

Indication on the display

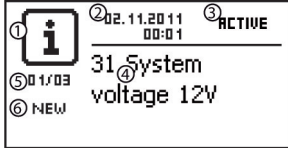

- ① Symbol for the type of event message:
i Information, ⚠ warning, ⊗ error
- ② Date/time at which the event occurred
- ③ Date/time at which the cause of the event message was corrected or 'ACTIVE', when the cause of the event message is still present.
- ④ Message text with error number
- ⑤ Counter: *No. of the displayed event message / Total number of event messages*
 Max. number of event messages = 30
- ⑥ 'NEW' indicates that the event messages has not yet been confirmed.

Function

Type **Information** (symbol i): A state or error exists that does not impair the functioning of the device.

Type **Warning** (symbol ⚠): An error exists that has caused the battery to be charged but the loads are only supplied to a limited extent.

Type **Error** (symbol ⊗): A serious error has occurred, due to which the correct functioning of the device cannot be guaranteed.

New event messages are displayed immediately. The messages disappear after they have been confirmed or their cause(s) have been corrected.

If messages exist whose cause has been corrected but have not been confirmed then ⊗ is shown in the information bar of the status display.

If an already confirmed error recurs then it is displayed again.

Operation

Confirming event messages

- ✓ An event message with the comment 'NEW' is displayed.
- ▶ Press 'ESC'/△/▽. The event message is confirmed.

Displaying event messages

- ✓ 'Main menu' ▶ 'Event log'
- ▶ Press △▽ to page through the event messages; see following "List of event messages".

Clearing the event log



All event messages are cleared.

- ✓ 'Main menu' ▶ 'System settings' ▶ 'Clear event log'
1. Press 'SET'. Fig. 16 appears.
 2. Press 'SET' for 1 s to clear the event log.

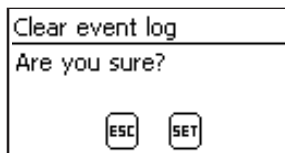







Fig. 16 Clear event log dialog





List of event messages















DANGER!

When correcting errors, observe the safety instructions in section 9.1.

Event message		Cause	Remedy	1)	2)
No.	Text				
02	Internal error	Error in the internal memory.	<ul style="list-style-type: none"> ■ A serious error has occurred. Contact the manufacturer. 		
04	Sensor defect: extern. temperature	Short circuit or open circuit in an external temperature sensor	<p>► Check the following points:</p> <ul style="list-style-type: none"> ■ External temperature sensor cable correctly connected to the controller? ■ Cable broken or short circuited? ■ External temperature sensor damaged? 	X	
05	Over-temperature device	The controller has become too hot and has switched off the load output.	<p>1. Allow the controller to cool down.</p> <p>2. Check the following points:</p> <ul style="list-style-type: none"> ■ Controller environment too hot (heating, direct sunlight)? ■ Dirty cooling fins? ■ Inadequate controller ventilation? ■ Installation safety requirements not adhered to (section 9.4)? 	X	
07	Battery voltage too low	The cell voltage of the battery has dropped below the minimum value.	<p>► Take the following measures if appropriate:</p> <ul style="list-style-type: none"> ■ Charge the battery with an external device if a directly connected load has deep discharged the battery. ■ Check the capacity of the battery if the event message is displayed frequently. Replace battery if necessary. ■ Measure the battery voltage with a voltmeter. Compare the measurement with the controller display. If the values deviate greatly then the controller is damaged. 	X	
08	Battery voltage too high	The cell voltage of the battery has risen above the maximum value.	<p>► Take the following measures if appropriate:</p> <ul style="list-style-type: none"> ■ Remove other charging sources connected to the battery. Problem corrected? ■ Measure the battery voltage with a voltmeter. Compare the measurement with the controller display. If the values deviate greatly then the controller is damaged. 	X	

Event message		Cause	Remedy	1)	2)
No.	Text				
09	Overload	<p>Attention</p> <ul style="list-style-type: none"> ■ Danger of destroying the converter through overloading. Loads that consume more current than can be supplied by the controller must be directly connected to the battery. ■ Always directly connect inverters to the battery! <p>Note</p> <p>If the event message occurs again when the load is connected then too many loads are connected to the controller. If the event message occurs again a certain time after the load is connected then individual loads are probably generating short-term peak currents, e.g. heavy-duty electric motors.</p>	<p>1. Switch off the loads to reduce the load current.</p> <p>2. Switch on the loads individually.</p> <p>3. Contact your dealer if this event message occurs again after all loads have been switched on. Specify whether the event message occurs immediately or a certain time after switching on the loads.</p>	X	
10	PV current too high	The maximum permissible module current has been exceeded because the solar module is overdimensioned.	► Contact your dealer.	X	
11	Load short circuit	A short circuit exists at the load output.	<ol style="list-style-type: none"> 1. Switch off all loads. 2. Switch off the load output, see section 13.5. 3. Correct the short circuit (wiring, load). 4. Switch on the load. 5. Switch on the load output. 	X	
13	Battery not connected	The solar module is supplying voltage but the battery is not recognised.	<p>► Take the following measures if appropriate</p> <ul style="list-style-type: none"> ■ Connect the battery. ■ Check the external battery fuse and replace if necessary. ■ Check the battery cable connections. ■ Check the battery cable for breakage. 	X	

Event message		Cause	Remedy	1)	2)
No.	Text				
14	Wrong battery polarity	The battery is connected to the controller with the wrong polarity.	▶ Connect the battery with the correct polarity.		
15	Wrong PV polarity	The solar module is connected to the controller with the wrong polarity.	▶ Connect the solar module with the correct polarity.		
19.. .24	Internal error	—	▶ Send the device to your dealer to be checked.		
26	Undefined system voltage	The system voltage (battery voltage) has not been automatically detected.	▶ Take the following measures if appropriate: ■ Check the battery and replace if necessary. ■ Use the expert menu to manually set the system voltage; see section 13.5.		
29	RTC not set	The time and date are not set.	Set the time and date.		
30	Self test failed.	The self test could not be performed correctly because the solar module or load were not disconnected or a power component or other components are defective.	■ Disconnect everything except the battery. If the self test still does not work, inform your dealer.		
31	System voltage XX V	The controller has detected a system voltage of XX V (battery voltage).	The message is displayed after the battery has been connected.		
32	Battery at load output	A voltage source (e.g. battery) has been connected to the load output			



Event message		Cause	Remedy	1)	2)
No.	Text				
33	MinMax out of Range	Wrong parameterisation	<ul style="list-style-type: none"> Parameterise again 		
34	Batterie-E-Fuse open	The overcurrent protection circuitry has triggered or incorrect polarity was detected.	Connect battery poles correctly. If the error persists, contact your dealer.	X	
	Settings incompatible	Parameter file not compatible	<ul style="list-style-type: none"> Save settings of a compatible device on the SD card 		
	File not found	No valid parameter file found on SD card	<ul style="list-style-type: none"> Save settings of a compatible device on the SD card 		
79	HS400 communication failed	No communication possible to registered HS400, RS-485 communication is interrupted.	<ul style="list-style-type: none"> Check cables. Connect the bus cables again. Check the slave power supply. Eliminate the interruption, restart HS400 		

¹⁾ X = the event message triggers switching on of the alarm output.

²⁾ Type of event message

15.2 Errors without event messages

The causes of the following errors cannot be controlled by the device. Therefore the device does not display an event message when one of these errors occurs.

Error	Possible cause	Solution
No display	Battery voltage too low	Pre-charge the battery
	External fuse for the battery has triggered	Replace the external fuse for the battery or reset it.
	Battery is not connected	1. Unclamp all connections.
	Battery is defective	2. Connect (a new) battery with the correct polarity. 3. Reconnect the solar module and loads.
Load cannot be operated or only for a short time	The deep discharge protection has switched off the output due to an excessively low battery voltage.	Charge the battery.
Load cannot be operated	External charging sources are not voltage-limited	<ul style="list-style-type: none"> ■ Check the external charging source. ■ Switch off external charging sources if necessary.
	Load incorrectly connected or faulty	<ul style="list-style-type: none"> ■ Connect load correctly. ■ Replace load.
Battery is not charged	Solar module not connected	Connect the solar module.
	Short circuit at solar module connection	Rectify short circuit.
	Incorrect solar module voltage	Use a solar module of a suitable voltage.
	Solar module defective	Replace the solar module.
Battery current value in the status display changes suddenly	Large pulse current	Tune the current consumption to match the battery capacity.
	Battery is defective	Replace the battery.
 appears in the status display while the sun is shining	Battery voltage too high	Check the installation.
 flashes in the status display	<p>Pre-warning of deep discharge protection; this symbol is displayed when</p> <ul style="list-style-type: none"> ■ $SOC < (\text{Deep discharge protection load} + 10\%)$ or ■ $\text{Battery voltage} < [(\text{Deep discharge protection load} + (0.05\text{ V} \times \text{number of battery cells}))]$. 	<ul style="list-style-type: none"> ■ Charge the battery. ■ Set the switch-off threshold of the <i>Load deep discharge protection</i> under 'Main menu' ▶ 'Output settings' ▶ 'Load' ▶ 'Low volt. discon. - LVD' ▶ 'Disconnection thresh.'

15.3 Self test

Function

The self test checks the main device functions.

Operation

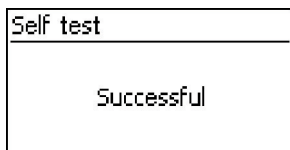
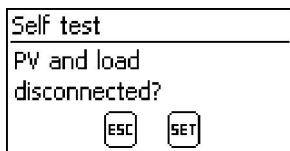

Attention

Danger of destruction of the controller. Disconnect the loads and solar module from the controller before starting the self test.

This is described in section 11.

1. Disconnect the cables from the 'AUX 1' and 'AUX 2' relay outputs.
2. Call up 'Main menu' ► 'Self test'. The dialog shown at the left is displayed.
3. Press and hold 'SET' for 1 second. The self test starts, the  symbol is displayed and the switching of the relays can be heard.
4. If no errors occur then the dialog shown at the left is displayed; otherwise 'Self test failed' is displayed.
5. Press 'ESC'.
6. If 'Self test failed' was previously displayed then correct the error using the event message menu ('Main menu' ► 'Event log').
7. Connect solar module and loads, as described in section 9.5.3, and section 9.5.4.
8. Connect cables to 'AUX 1' and 'AUX 2'.

16 Maintenance

16.1 Controller

The controller is basically maintenance-free. Despite this, it is a good idea to regularly check that the cooling fins on the front and rear sides of the device are free of dust. Clean the device when necessary as described below.



ATTENTION!

Danger of damage to components.

- Do not allow cleaning agents or objects to enter the inside of the controller from the front (gaps around the operating elements).
- Do not use especially the following cleaning agents:
 - Solvent-based cleaning agents
 - Disinfection agents
 - Coarse or sharp-edged cleaning agents

16.1.1 Removing dust

- ▶ Dust should be removed using compressed air (max. 2 bar).

16.1.2 Removing heavy soiling



DANGER!

Risk of death by electrocution! Use cleaning agents only with a slightly damp cloth.

1. Switch off loads, solar module and battery, as described in section 9.1.
2. Remove heavy soiling with a slightly damp cloth (use clear water). If necessary, use a 2 % hard soap solution instead of water. After cleaning, remove any soap residue using a slightly damp cloth.
3. Switch on the battery, solar module and loads.

16.1.3 Checking the charging functionality

1. If the *Battery* symbol flashes, despite a long period of sunshine and correctly connected solar module then measure the battery voltage.
2. If the battery voltage is very low then charge the battery with an external charger or replace the battery.
3. Execute self test (section 15.3).
4. Contact your dealer if the batter voltage is greater than 17/34 VDC (Tarom 4545) or 17/34/68 VDC (Tarom 4545–48).

16.1.4 System

We recommend checking all system components at least once a year, according to the manufacturer's specifications. The following maintenance work is generally recommended:

- Check the cable strain relief.
- Check that all cable connections are secure.
- Tighten screws if necessary.
- Check all contacts for signs of corrosion.
- Check the acid levels in the battery according to the manufacturer's specifications.

17 Disposal

The crossed-out wheellie bin symbol on the device indicates that this product must not be disposed of with the normal household waste. It must be taken to a collection point for waste electrical and electronic equipment. Information on the collection points can be obtained from the local waste disposal company, the next collection point for household waste or from the dealer where you bought your device.

Electrical devices can contain hazardous components which, if they are disposed of improperly, may do harm to environment and human health. Separate collection ensures proper treatment, recovery and reuse of the raw materials contained in the waste equipment according to the provisions of current legislation.

The device packaging consists of recyclable materials.

18 Technical data

18.1 Controller

	Tarom 4545	Tarom 4545–48
Characterisation of the operating behaviour		
System voltage	12 / 24 VDC	12 / 24 / 48 VDC
Own consumption	30 mA	
DC input side		
Max. input voltage ^{1) 2)}	60 VDC	100 VDC
Module current ^{1) 2)}	45 A	
DC output side		
Load output		
Load current ²⁾	45 A; switch-on current applies to resistive loads	
Maximum current (10 s)	45 A / 58 A	52 A
Startup current (0.5 s)	56 A / 72 A	64 A
Maximum pulse current (10 ms)	140 A / 180 A	160 A
Charge completion voltage:		
Factory setting	14.1 VDC / 28.2 VDC	56.4 VDC
Setting range	12.6 VDC ... 14.4 VDC 25.2 VDC ... 28.8 VDC	50.4 VDC ... 57.6 VDC
Boost charging		
SOC voltage control (charge completion voltage)		
Factory setting	70 % 14.4 VDC / 28.8 VDC	70 % 57.6 VDC
Setting range	40 % ... 70 % 13.2 VDC ... 15.6 VDC / 26.4 VDC ... 31.2 VDC	40 % ... 70 % 52.8 VDC ... 62.4 VDC
Equalise charging		
SOC voltage control (switch-off threshold)		
Factory setting	40 % 15.0 VDC / 30.0 VDC	40 % 60.0 VDC
Setting range	10 % ... 60 % 13.8 VDC ... 15.6 VDC / 27.6 VDC ... 31.2 VDC	10 % ... 60 % 55.2 VDC ... 62.4 VDC

	Tarom 4545	Tarom 4545–48
Deep discharge protection	SOC voltage control (switch-off threshold)	
Factory setting	30 % 11.7 VDC / 23.4 VDC	30 % 46.8 VDC
Setting range	10 % ... 70 % 9.6 VDC ... 12.3 VDC / 19.2 VDC ... 24.6 VDC	10 % ... 70 % 38.4 VDC ... 49.2 VDC
Switch-on voltage	SOC voltage control	
Factory setting	50 % 12.5 VDC / 25.0 VDC	50 % 50.0 VDC
Setting range	15 % ... 100 % 9.8 VDC ... 15.6 VDC / 19.7 VDC ... 31.2 VDC	15 % ... 100 % 39.4 VDC ... 62.4 VDC
Pre-warning of deep discharge protection	deep discharge protection value + 10 % or 0.3 / 0.6 VDC	deep discharge protection value + 10 % or 1.2 VDC
Minimum supply voltage (battery voltage)	10.0 VDC / 10.0 VDC	10.0 VDC
Configurable multifunctional contacts AUX 1, AUX 2		
Switching voltage for resistive loads	30 VDC@1.0 A, 60 VDC@0.3 A, 125 VAC@0.3 A, 230 VAC@0.1 A	
Application conditions		
Ambient temperature	–10 °C ... +60 °C	
Equipment and design		
Settable battery types	lead acid battery '(factory setting)', lead gel/AGM battery	
Terminal clamps (fine-wire / single wire)	25 mm ² AWG 4 / 35 mm ² AWG 2 tightening torque 2.5 ... 4.5 Nm	
Degree of protection	IP 31	
Dimensions (X x Y x Z)	218 x 134 x 65 mm	
Weight	800 g	
Display		
Type	graphic display	
Resolution	128 x 64 pixels	
External battery fuse	≈ 100 A (= max. double of the operating current)	

- 1) When designing the maximum input voltage of the solar module, take the following into consideration: at temperatures < 25 °C the open-circuit module voltage is higher than the value specified on the type plate.
- 2) Technical data at 25 °C / 77 °F



Technical data that varies from the above is given on a device label. Subject to change without notice.

18.2 Connection cables

Component	Max. cable length		Max. recommended current	Recommended cross-section		Insulation ¹⁾
	Prescribed	Recommended		mm ²	AWG	
Solar module	30 m	10 m	20 A	10	8	85 °C
			45 A	16	6	
Battery	3 m	2 m	30 A	16	6	85 °C
			45 A	16	6	
Load	30 m	5 m	40 A	16	6	85 °C
	30 m	20 m	45 A	25	4	
Master/Slave bus, respective total length	25 m	10 m	–	–	–	–
Temperature sensor	10 m	2.8 m	–	–	–	–

¹⁾ Temperature resistance of the insulation



WARNING!

Contact your dealer for information on the recommended cable cross section when you require longer cable lengths for the solar module, battery and loads than specified for the **recommended** cables in the table above.

18.3 Protocol of the open UART interface

18.3.1 Settings

Signal / information	Value	Units	Action
UART bits per second	4800	Baud	Fixed value, not configurable.
UART data bits	8	bit	8 bit data; fixed value, not configurable.
UART parity	None		Fixed value, not configurable
UART stop bits	1		Fixed value, not configurable
UART flow control	None		Fixed value, not configurable.
UART transmission interval	60 ± 1	s	<ul style="list-style-type: none"> ■ The data is output at a non-configurable fixed interval of 60 s. ■ No external data transfer request.
UART data output			<ul style="list-style-type: none"> ■ Data is output in a fixed, non-configurable sequence. ■ The units are not specified, e.g. V, A, °C, Ah. ■ The values are sent as ASCII characters. ■ The decimal point is denoted with a full-stop. A maximum of 1 decimal character is displayed. ■ A semicolon { ; } is output as the separating character between values. ■ If a value is not available then {#} is output. A CR + LF sequence is output at the end of the data transmission.

18.3.2 UART Data

Signal / information	Value	Units	Action
UART Data info 1	Version number		
UART Data info 2	Date		YYYY/MM/DD
UART Data info 3	Time		hh:mm, 24 h format
UART Data info 4	Battery voltage	V	Battery voltage at terminals 'B+'/'B-'
UART Data info 5	PV voltage 1	V	Voltage at module connection
UART Data info 6	PV voltage 2	V	'#' Information not available on the device
UART Data info 7	SOC	%	<ul style="list-style-type: none"> ■ SOC value ■ '#' with the voltage control setting
UART Data info 8	Result of capacity test	Ah	'#' Information not available on the device
UART Data info 9	Total charge/discharge current of battery	A	<ul style="list-style-type: none"> ■ Information on current according to <i>'Menu' ► 'Settings' ► 'Battery' ► 'Control mode' ► 'Sensor member list'</i> ■ Currents of the selected sources are added according to their prefix ■ Charge current is displayed as positive ('+') ■ Discharge current is displayed as negative ('-')
UART Data info 10	PV1 current	A	PV current on the module connection '#' When PV module is not available.
UART Data info 11	PV2 current	A	'#' Information not available on the device.
UART Data info 12	Input current	A	Current of the module connection used for charging the battery and for the load output on the device.
UART Data info 13	Total charge current of battery	A	Total of the selected energy input sources
UART Data info 14	Load current	A	Current that is taken from the load output of the device.
UART Data info 15	Total discharge current of battery	A	Total of the selected energy output sources
UART Data info 16	Temperature	°C	<ul style="list-style-type: none"> ■ Temperature of the internal sensor or ■ Temperature of the external battery temperature sensor, if connected

Signal / information	Value	Units	Action
UART Data info 17	Error		Error state: 0-No errors, 1-Information, 2-Warning, 3-Error
UART Data info 18	Charging mode		Charge mode identifier, F, B, L, S
UART Data info 19	Load output		Switching state of load output 0-OFF, 1-ON
UART Data info 20	AUX 1		Switching state of AUX 1 relay 0-OFF, 1-ON
UART Data info 21	AUX 2		Switching state of AUX 2 relay 0-OFF, 1-ON
UART Data info 22	Energy input 24 h	Ah	Ah meter of the energy input members total during the period from 00:00 to 23:59
UART Data info 23	Energy input/total	Ah	Ah meter of the energy input members total since initial commissioning
UART Data info 24	Energy output 24 h	Ah	Ah meter of the energy output members total during the period from 00:00 to 23:59
UART Data info 25	Energy output/total	Ah	Ah meter of the energy output members total since initial commissioning
UART Data info 26	Derating	Ah	0- Derating not active, 1- Derating active
UART Data info 27	Checksum		A CRC16 checksum is generated. Name: 'CRC-16-CCITT/openUART' Width: 16 Direction: right shift Polynomial: 0x8408 CCITT reversed, 2 bytes long, stored as high-byte, low-byte. The CRC is calculated with semicolons and without CR+LF.
UART Data info 28	End of data		CR + LF

18.4 Recording data on an SD card

When data logging is activated, separate data logging files are created for each of the following StecaLink member devices:

- Tarom master device
- PA HS400

The data files are stored in a predefined directors structure.

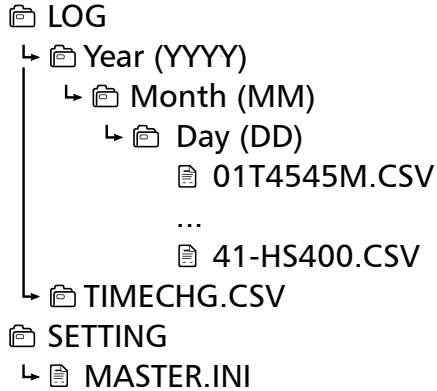

File name structure of the data files

'StecaLink bus address' + 'Device name' + '.CSV'

Example: 40-HS400.CSV

18.4.1 Master data file

Header data in the created CSV file

Manufacturer	Device name	Serial number
Steca Elektronik GmbH	Tarom 4545 or Tarom 4545-48	20-digit serial number <ul style="list-style-type: none"> ■ Steca part number (6 digits) ■ Coded month/year of production (2-digits) ■ Steca RM number (8 digits) ■ Consecutive number (4 digits)

Content of data file

Information/column	Value
Date	DD/MM/YYYY, according to the configured date format.
Time	hh:mm:ss, according to the configured time format.
Vbat[V]	Battery voltage at terminals B+/B-.
SOC[%]	<ul style="list-style-type: none"> ■ SOC value ■ '-' with the voltage control setting.
Ipv[A]	PV current on the module input
Iin[A]	Input current that is used on the device for battery charging and/or load.
Iout[A]	Load current that is taken from the load output of the device.
Ibat_total[A]SOC	<p>Current information according to the sources selected in the member list in 'Menu' ► 'Settings' ► 'Battery' ► 'Control mode' ► 'Sensor member list'.</p> <ul style="list-style-type: none"> ■ The currents of the selected sources are added according to their prefix. ■ Charge current is displayed as positive ('+') ■ Discharge current is displayed as negative ('-')
Icharge_total[A]	Total of the selected energy input sources.
Iload_total[A]	Total of the selected energy output sources.
ChargeMode	Charge mode identifier: F, B, E, S.
ErrorState	Error state: 0-No errors, 1-Information, 2-Warning, 3-Error.
ErrorNr	<ul style="list-style-type: none"> ■ Error code ■ '-' if no value is present.

Information/column	Value
StateLoad	Switching state of load output Off; On
StateAux1	Switching state of AUX 1 relay Off; On
StateAux2	Switching state of AUX 2 relay Off; On
Ah_in_24h_M[Ah]	Ah meter of the energy introduced by the device 00:00 to 23:59.
Ah_in_total_M[Ah]	Ah meter of the energy introduced by the device since initial commissioning.
Ah_in_24h_SYS[Ah]	Ah meter of the energy input members total during the period from 00:00 to 23:59.
Ah_in_total_SYS[Ah]	Ah meter of the energy input members total since initial commissioning.
Ah_out_24h_SYS[Ah]	Ah meter of the energy output members total during the period from 00:00 to 23:59.
Ah_out_total_SYS[Ah]	Ah meter of the energy output members total since initial commissioning.
Ah_Load_24h_M[Ah]	Ah meter of the energy discharged on the load output 00:00 to 23:59.
Ah_Load_total_M[Ah]	Ah meter of the energy discharged on the load output since initial commissioning.
BatTemp[°C]	■ Value of the external battery temperature sensor, if connected. ■ '-' if no value is present.
Ophours[h]	Number of operating hours since initial commissioning of the device.

18.4.2 TIMECHG data file

If the date and time settings are changed on the device, this has an impact on data recording.

Changes to the date and time settings are recorded in a special data file in order to document these changes.

Changes are only documented in the TIMECHG.CSV data file when the SD card data logging is activated.

Contents of TIMECHG.CSV

Date before the change	Time before the change	->	Date after the change	Time after the change
DD/MM/YYYY	hh:mm:ss		DD/MM/YYYY	hh:mm:ss

18.4.3 PA HS400 data file

Header data in the created CSV file

StecaLink slave address	Device name	Serial number
40 – 49	HS400	18-digit serial number <ul style="list-style-type: none"> ■ Steca part number (6 digits), ■ Steca RM number (8 digits), consecutive number (4 digits).

Contents of the CSV data file

Information/column	Value
Date	DD/MM/YYYY, according to the configured date format.
Time	hh:mm, according to the configured time format.
I_integral	Current information of the PA HS400 in A.
Position	The current direction of the measuring position assigned to this sensor in the master, '-' when no value is present. 1 – Not installed 2 – Charge sensor 3 – Discharge sensor 4 – Charge/Discharge sensor
SOC_relevant	Use of the PA HS400 0 – Only displayed in the status window 1 – Sensor is taken into consideration for SOC calculation
Number_of_turns	The number of turns configured for this sensor in the master.
Reading_inverted	The current direction configured for this sensor in the master. 0 – Value not inverted 1 – Value inverted

19 Guarantee conditions

The Steca guarantee conditions are available in the Internet at:

www.steca.com/pv-off-grid/warranties

19.1 Exclusion of liability

The manufacturer can neither monitor the compliance with this manual nor the conditions and methods during the installation, operation, usage and maintenance of the controller. Improper installation of the system may result in damage to property and, as a result, to bodily injury.

Therefore, the manufacturer assumes no responsibility and liability for loss, damage or costs which result from or are in any way related to incorrect installation, improper operation, incorrect execution of installation work and incorrect usage and maintenance.

Similarly, we assume no responsibility for patent right or other right infringements of third parties caused by usage of this controller. The manufacturer reserves the right to make changes to the product, technical data or installation and operating instructions without prior notice.

20 Contact

In the case of complaints or faults, please contact the local dealer from whom you purchased the product. They will help you with any issues you may have.

Dealer:

Street & no.

City:

.....

Phone:

Fax:

Email:

Internet:

Stamp

21 Notes

Controller

Type

Serial number

